











Assembly Instruction

ITEM NO:9957GRY/CH-3

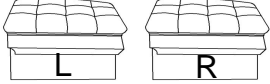
Sofa, 2 pillows

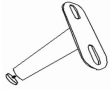
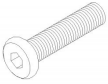
NOTE: Do not use power tools for assembly. Power tools increase the risk of over tightening which lead to splitting or cracking the wood.

COMPONENT LIST

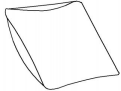
NO.	DRAWING	QTY	DESCRIPTION
A		1	LSF SEAT FRAME
B		1	RSF SEAT FRAME
C		2	LSF/RSF BACK CUSHION
D		4	PLASTIC LEG
E		2	METAL MIDDLE LEG
F		4	BOLT(5/16"*1-3/8")
G		6	LOCK WASHER(1/2"*1/2")
H		6	LOCK WASHER(4/5"*4/5")
I		1	ALLEN KEY(1"*3")
J		2	BOLT(5/16"*2-1/5")
K		2	PILLOW

legs are packed with bubble bag and stored on the bottom of seat, please take out for assembly

Step 1 Secure the two individual seat frame (A&B) together with
2 pcs bolt (J)

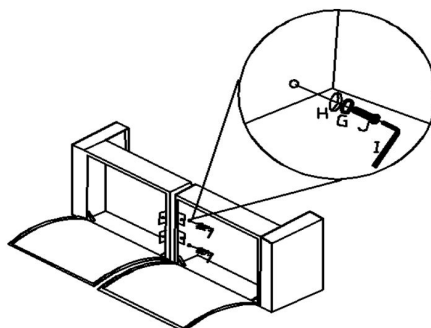

STEP 2:

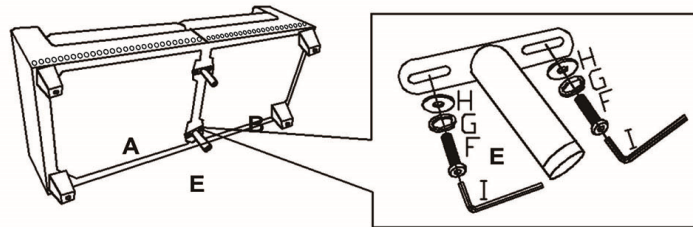

STEP 3:

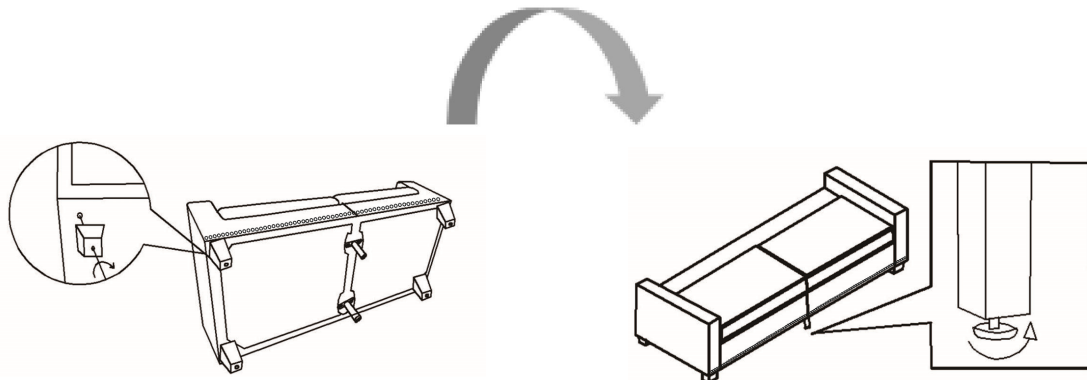

STEP 4:

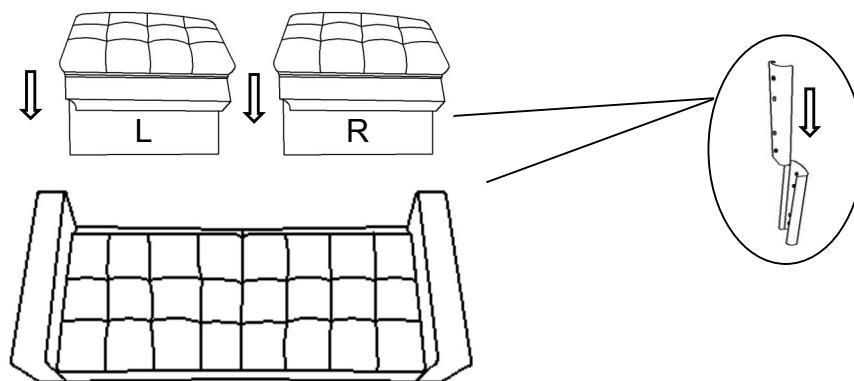

STEP 5: COMPLETED

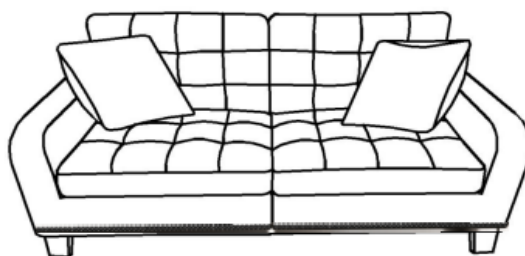

CARE INSTRUCTION FOR 100% POLYESTER FURNITURE:

In order to maintain the original appearance of your 100% polyester furniture, please follow below care procedures:

- Avoid exposing furniture directly to sunlight or heating and air conditioning outlets. Sunlight and / or exposure to heating and air conditioning outlets will fade/damage 100% polyester. Do not place your upholstered furniture too close to windows, radiators, or vents, and be sure to use window treatments to block the sun's rays.
- Wipe with a soft brush to remove dust.
- Wipe 100% polyester with professional cleanser.



For items use on wooden floor, hard surfaces or carpets, it is recommended to install protective pads under all legs and supports to avoid/prevent from damages/scratches and discoloration.